

Screen House 10x10 Feet Owner's Manual

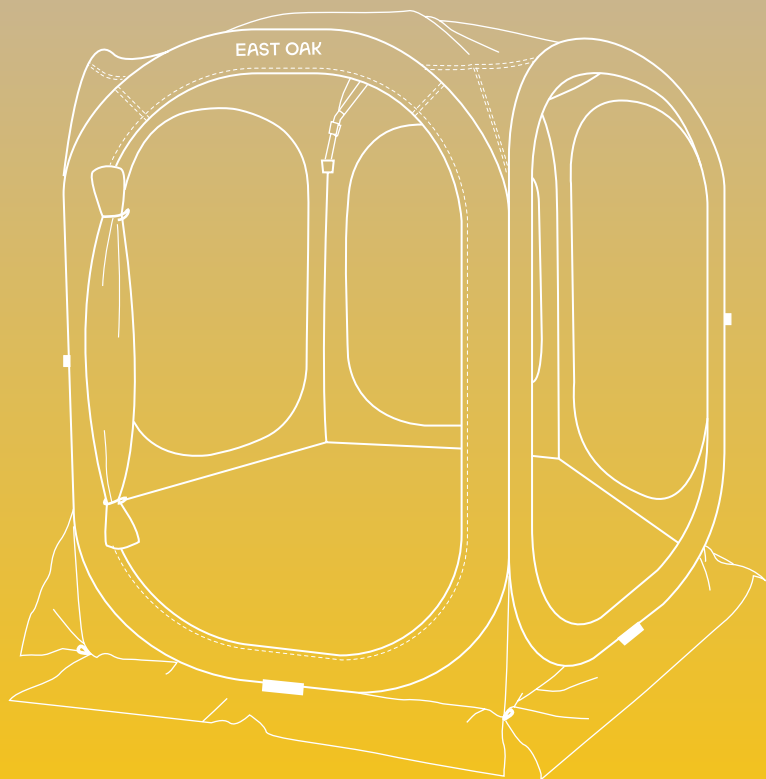

EAST OAK

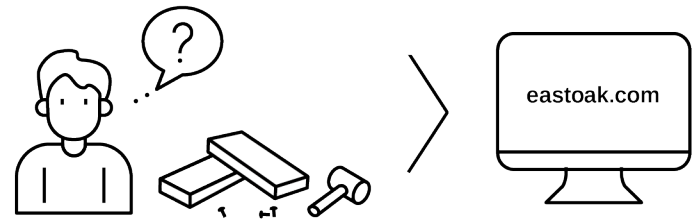

**Questions? Comments?
Reach out to us for expert support!**

✉ support@eastoak.com

🌐 eastoak.com

☎ 1-833-EAST-OAK (USA)

(1-833-327-8625) Mon-Fri 8am-8pm EST

Follow [eastoakliving](#) on



Claim your 3-year warranty
at eastoak.com/warranty

**Please scan the QR code
to view the installation video**

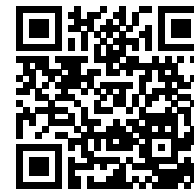

IMPORTANT INFORMATION

⚠️ DANGER Misuse could result in a serious accident or death.

- This screen house is made with flame resistant fabric which meets CPAI-84 specifications. It is not fireproof. The fabric will burn if left in continuous contact with any flame source. The application of any foreign substance to the screen house fabric may render the flame resistant properties ineffective.
- Do not keep fuel, or flammable items for replenishing the fuel, inside the screen house.

⚠️ DANGER Misuse could result in serious injury to the user.

- Pay close attention to the weather. If extreme weather is in the forecast, pack up screen house and evacuate to a safe place.
- The screen house opens forcefully. Be cautious when opening by making sure you release the secured webbing slowly away from FACE, BODY, and others.
- DO NOT recommend using when the wind force reaches level 6 (10.8-13.8 m/s). Otherwise the screen house will be blown down and damaged!
- It is required to pull all guylines to get enough windproof, and sandbags, ground stakes as well.
- Choose a flat, well-drained area with firm ground to pitch the screen house. Choose an area where there is no chance of avalanches, landslides, wind gusts or sudden flooding.

⚠️ CAUTION Misuse could result in injury to the user and/or damage to property.

- This product is not intended to be in permanent use.
- Do not assemble or use the screen house close to a bonfire, fireworks, etc. Flying sparks can create holes in the tent fabric.
- Firmly secure guylines, ground stakes, telescoping pole and sandbags, etc.
- If the screen house is left in the sun for long periods, the materials may fade in color or the fabric may deteriorate and lose strength. Do not leave the tent set up permanently.
- DO NOT drag the product (including the handbag) on the ground, which will cause the cloth to wear and tear.
- Keep away from sharp items to prevent cuts, rips, and other damage!
- This screen house is not waterproof.
- Please put the screen house away when not in use.

PARTS LIST

1



User Manual x1
Certificate Card x1
Warranty Card x1

2



Ground Stakes
6mm*22mm x12

3



Guyline x6

4



Φ7.9mm*352mm
Telescoping Poles x3

5

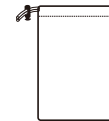

Storage Bag
(For Ground Stake) x1

6



Sandbags x6

7



Storage Bag
(For Telescoping Poles) x1

8



Elastic Band x2

9



Zip-up Bag x1

INSTALLATION

1. Take out the screen house from the zip-up bag, and remove the elastic band for securing. Please ensure you are in an open space without another person within 3 meters around. Hold the top with your hands (holding all panels), and throw it forward in a vertical position. The Screen House will pop up automatically.

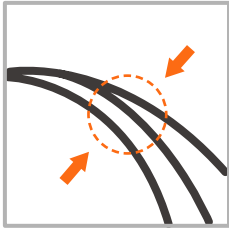

Hold the top with your hands (holding all panels).

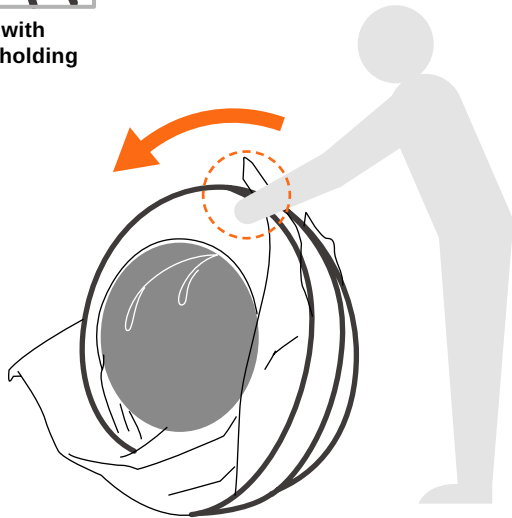

NOTE: Please ensure you are in an open space without another person within 3 meters around.

2. Make the screen house upright, pull open each panel from inside to outside, and adjust it properly to a regular hexagon.

2.1

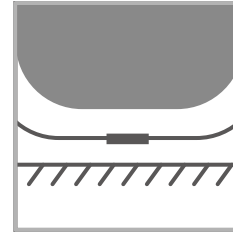

Pull open each panel from inside to outside.

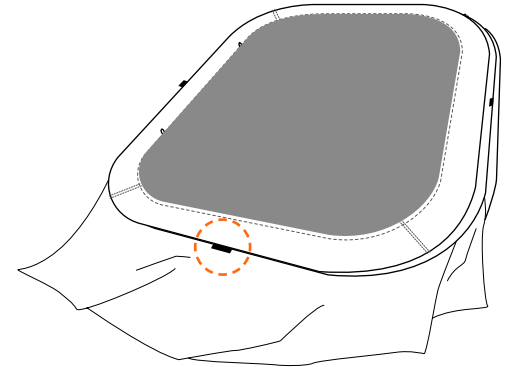
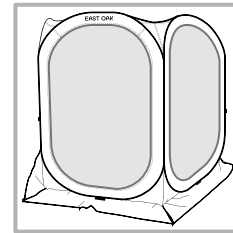

2.2

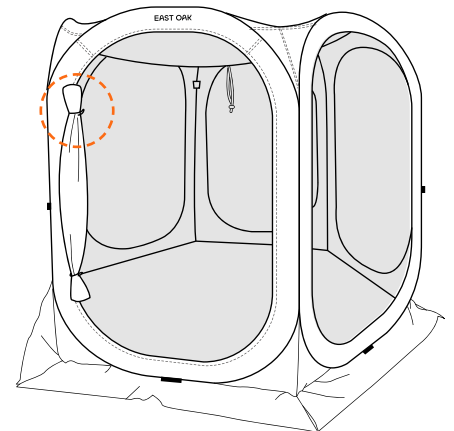
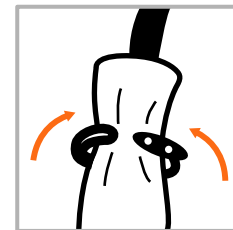

3. Connect the telescoping poles with both ends downwards, pass through the woven tapes on the ceiling, insert them into the small bags marked with red circles, and secure them with the touch fasteners on the side. After the installation of all 3 poles, draw the woven tape in the center to the tightest extent, and fix the position.

3.1

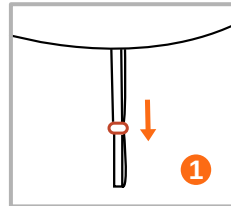
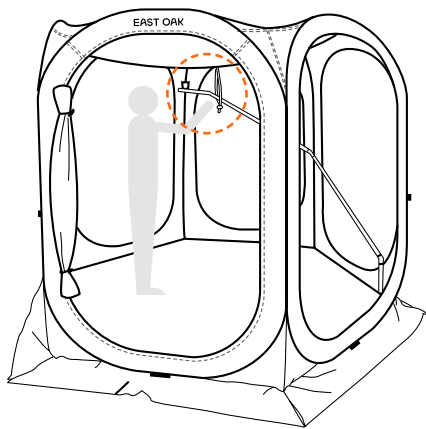
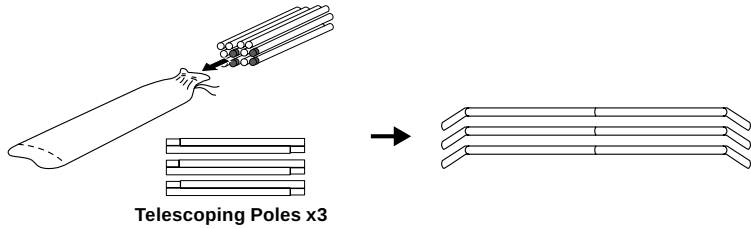

Release the drawcord buckle downward.

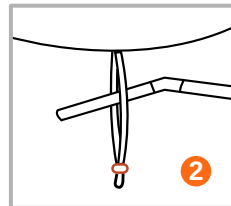

Connect the telescoping poles with both ends downwards, pass through the woven tapes on the ceiling.

3.2

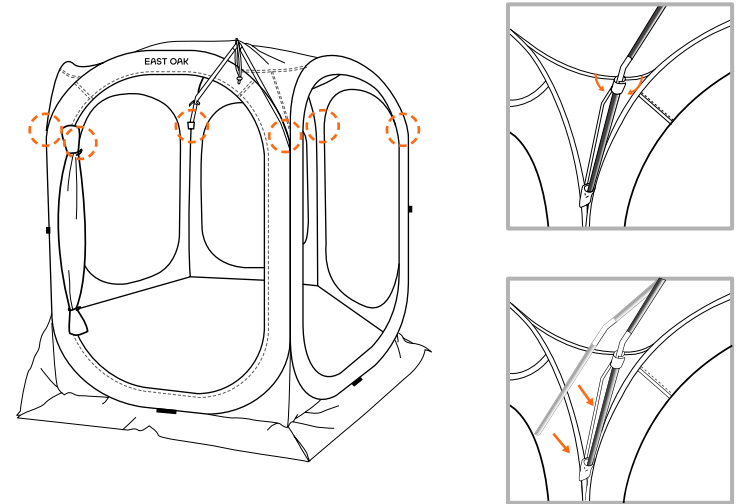

3.3

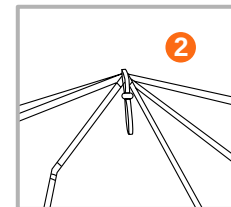
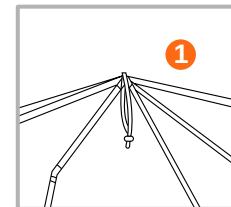

Tighten the buckle of the drawstring upwards.

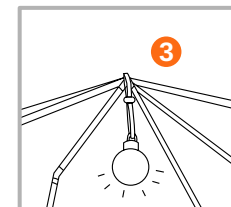
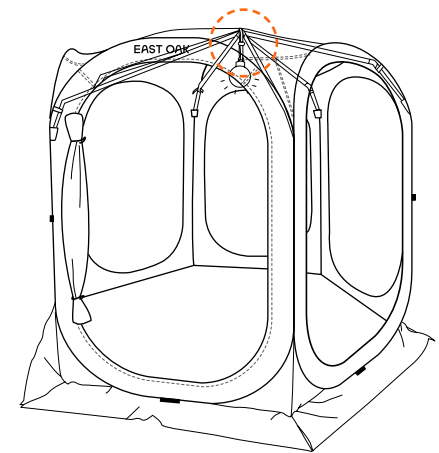

Notice: Light needs to be purchased separately.

4. Adjust the shape properly, and secure the screen house with ground stakes. If it is used on cement floor, you may fill the provided sandbags with sand and soil, and connect them with guylines.

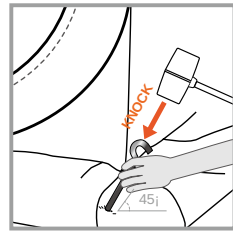
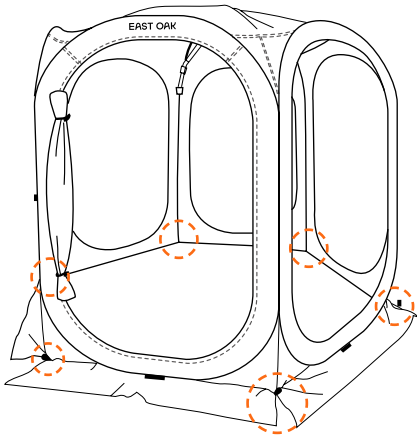

Secure the screen house with ground stakes.

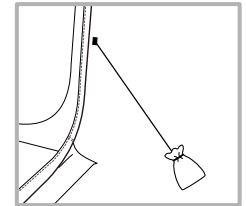
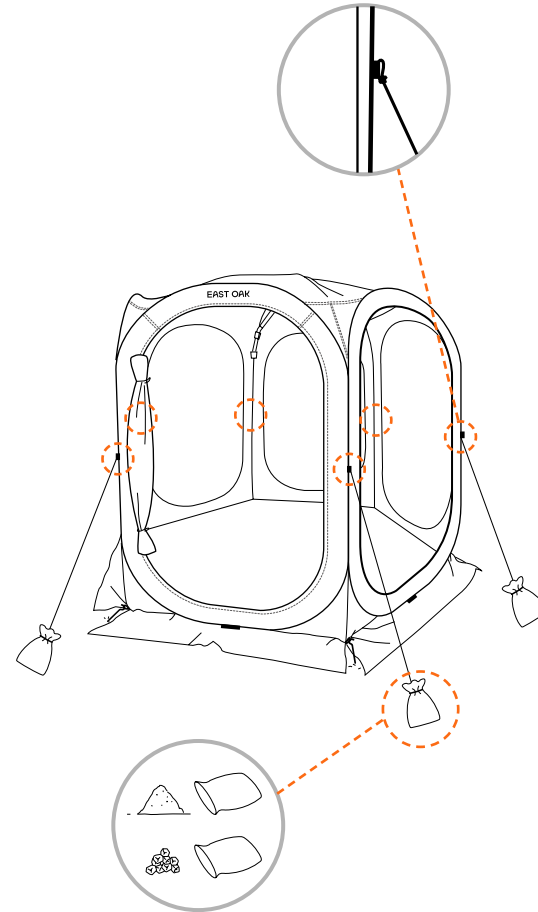

You may fill the provided sandbags with sand and soil.

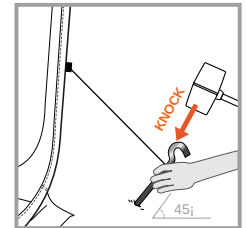
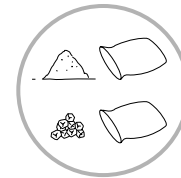

You may fix it on the ground with ground stakes and connect it with windproof ropes.



NOTE:

Ground stakes should be inserted into the ground at an angle of 45 degrees and perpendicular to the guylines.

FOLD-DOWN

- 1.** Pull out the tent pegs from the ground, remove the windproof ropes, and empty the sand and soil in sand bags. Loosen the woven tape in the center, pull apart the touch fasteners, take out the ends of fiber glass poles from the small bags marked with red circles and then fold them. Fold all three telescoping poles successively.

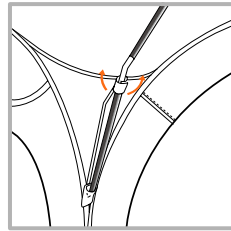
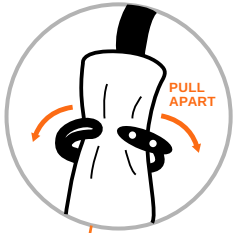

Loosen the woven tape in the center, pull apart the touch fasteners.

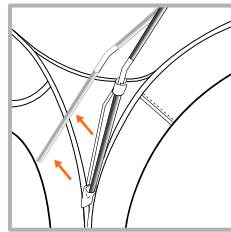
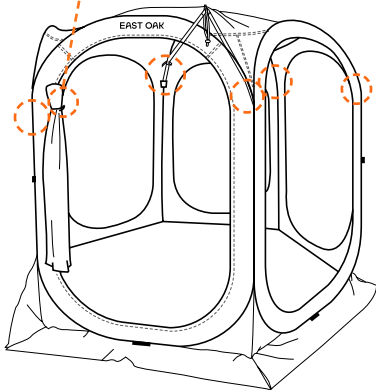

Take out the ends of telescoping poles from the small bags marked with red circles and then fold them.

- 2.** Zip up the screen house on the panel, and push it down directly. The 6 panels will be collapsed into 3 panels. Fold them into one panel. Tidy up the excess material.

2.1

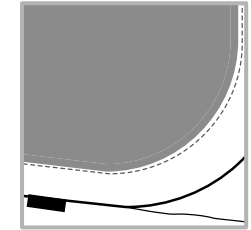
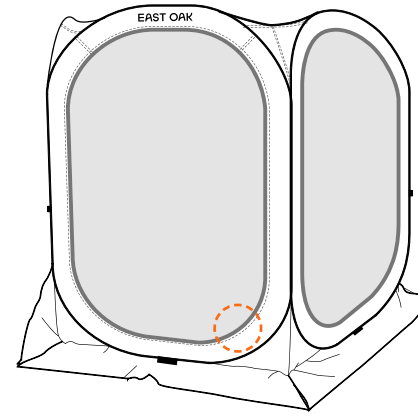

Zip up the screen house on the panel.

2.2

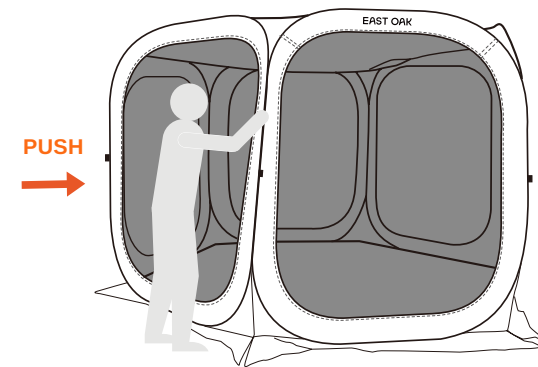

2.3 Push both sides together like a book. Please ensure that the product is laid flat and in place without bending or folding.

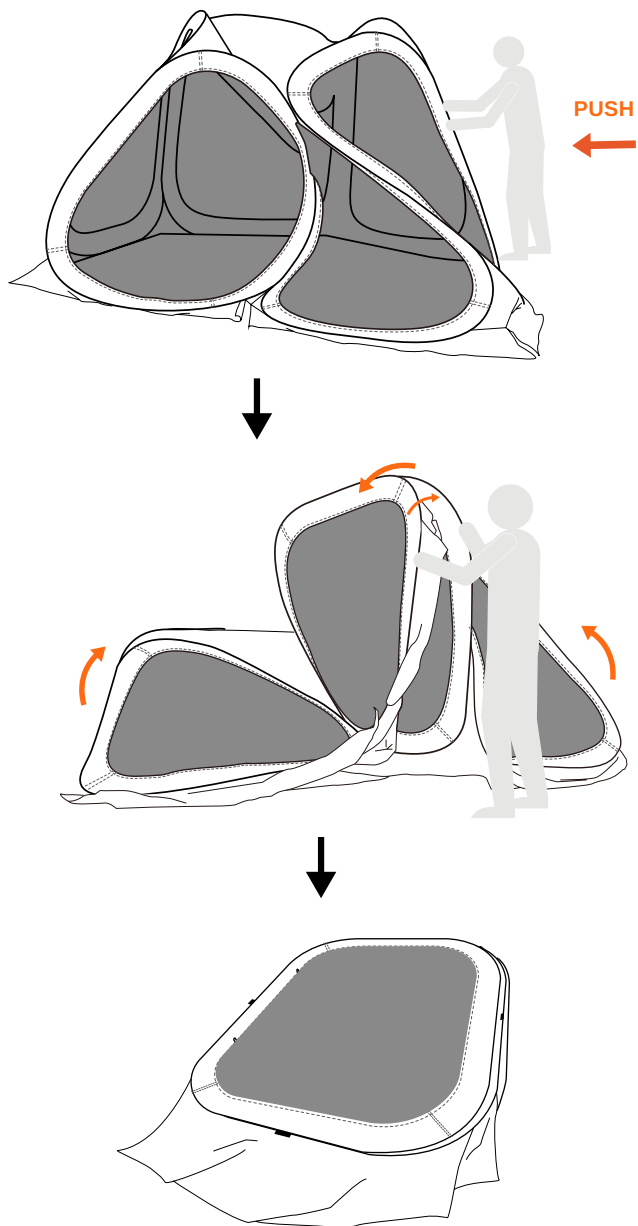

3. Folding storage of the screen house.

3.1 Fold the top panel of the screen house to the bottom of black gauze.



NOTE:

For the convenience of quick folding, it is recommended to step on the red circle for folding.

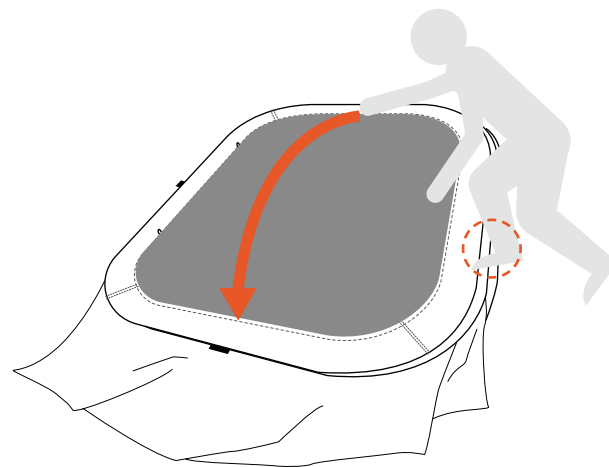

3.2 Press the screen house down with your knee or foot. At this time, the screen house will be separated into the right and left sections.

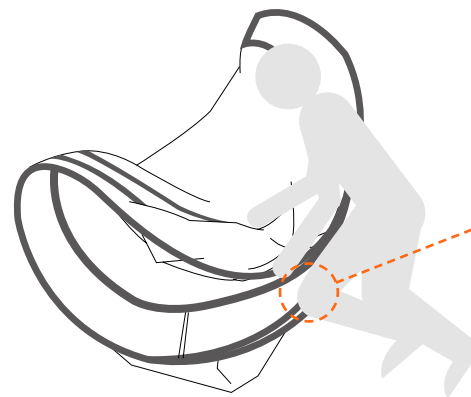

NOTE:

For the convenience of quick folding, it is recommended to step on the red circle for folding.

3.3 Pull them towards yourself, make the right section overlap the left section a little, and then hold them with your right hand.

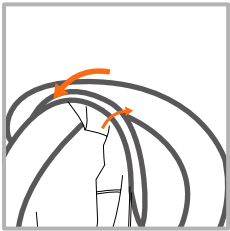

The right section overlap the left section a little, and then hold them with your right hand.

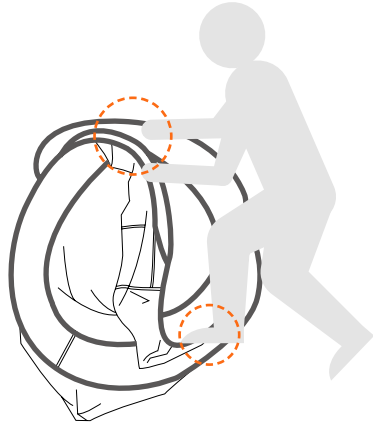

3.4 Lift your knee or foot, push inwards the position held down by your knee or foot previously with your left hand, and hold it down with your right hand to complete the fold-down.

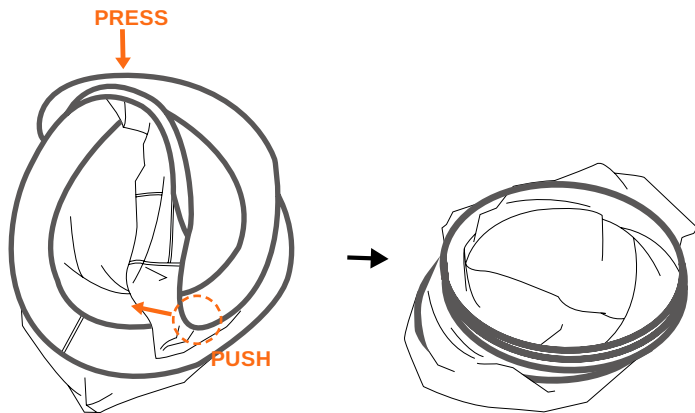

NOTE:

Pay attention to holding it down while pushing it. When folding, release the folding edge and no longer press it down. If you have any questions, please focus on videos.

4. Bind and hold the collapsed screen house in place with the elastic band, and put in all accessories.

Tips: In case of distortion or deformation of the screen house, it may be caused by the displacement of steel wires, which can be restored by holding any of its corners and shaking it.

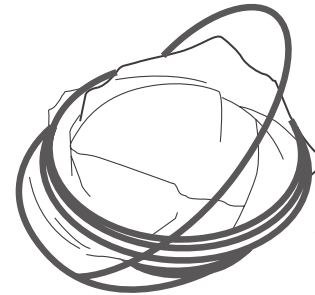

Bind and hold the collapsed screen house in place with the elastic band.

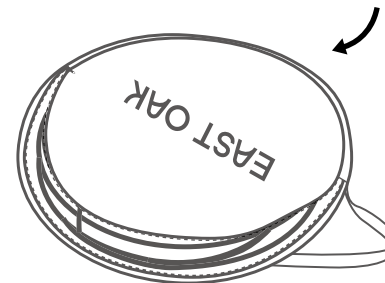
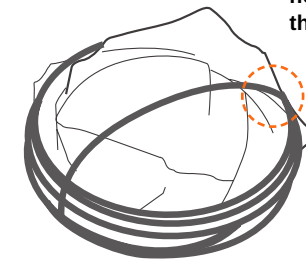

NOTE:

Please follow the above steps to operate correctly. Prevent accidental injury caused by misoperation.

FEATURES

- Sun protection (UPF50+)
- Anti-Mosquito
- Automatic pop-up, easy to install and store
- Stable structure, better wind resistance than similar products
- The higher ceiling enhances comfort levels
- Good ventilation
- Small storage volume, easy to carry out

WHAT'S IN THE BOX

- Screen House
- User Manual
- Ground Stakes
- Guylines
- Telescoping Poles
- Elastic Band
- Sandbags

WARRANTY POLICY

GUARANTEED 3-YEAR WARRANTY

Thank you for choosing East Oak. This product is covered by our company warranty for up to 3 years from its original purchase date.

CLAIM WARRANTY

If you'd like to claim your product's warranty, register your new product on our website at www.eastoak.com/warranty.

WARNING

Cancer and reproductive Harm
www.P65Warnings.ca.gov.

EAST OAK

✉ support@eastoak.com

🌐 eastoak.com

☎ 1-833-EAST-OAK (USA)